

DIMENSIONED DRAWINGS FOR THE ELIMINATOR SS ACTUATOR

Dimensions in inches

U-Parallel Offset Motor Configuration

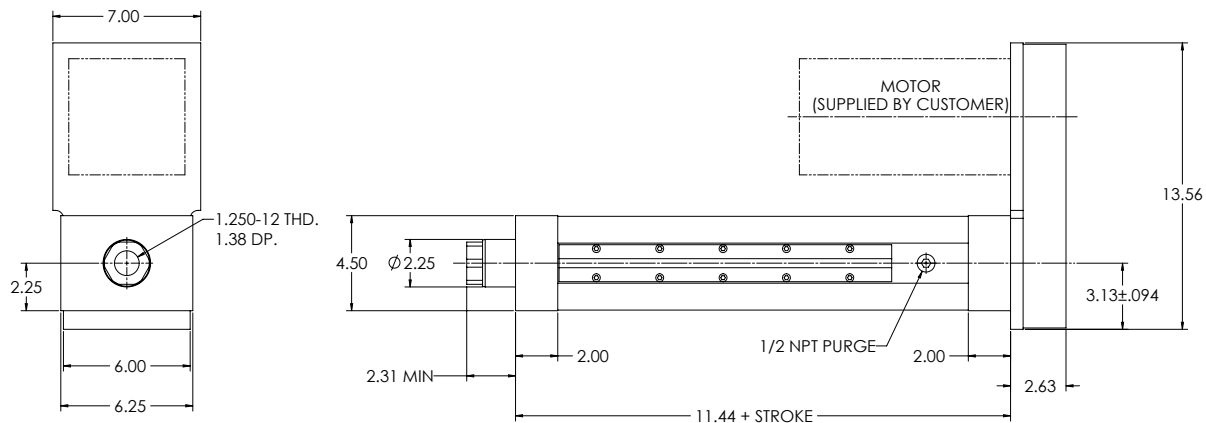

L-Inline Motor Configuration

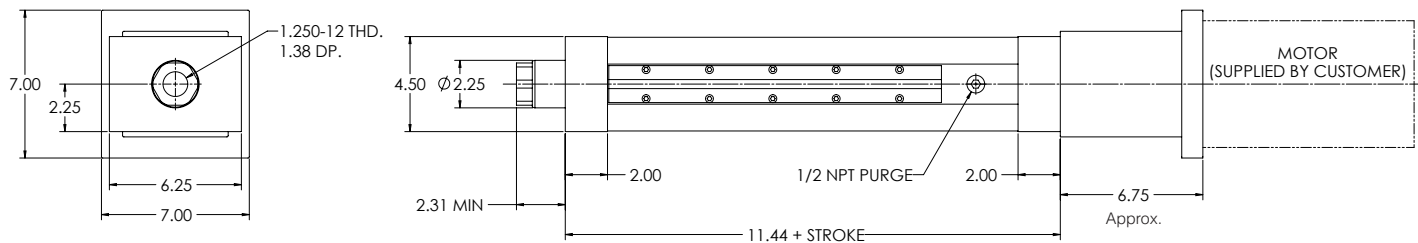

DIMENSIONED DRAWINGS FOR THE ELIMINATOR SS ACTUATOR

Dimensions in inches

Bottom Mount Dimensions

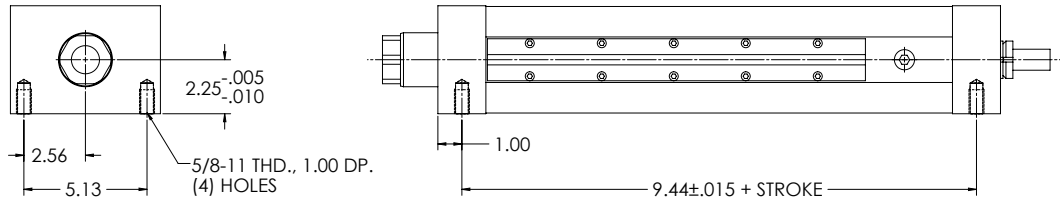

Front Flange Dimensions

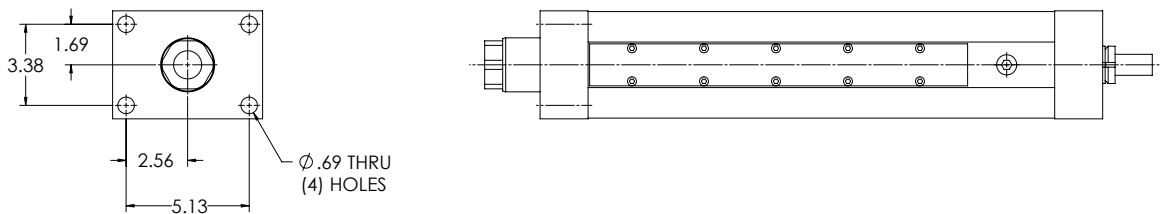

Foot Mount Dimensions

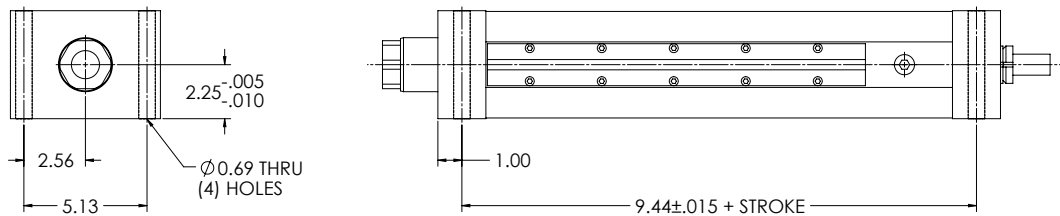

Trunnion Mount Dimensions

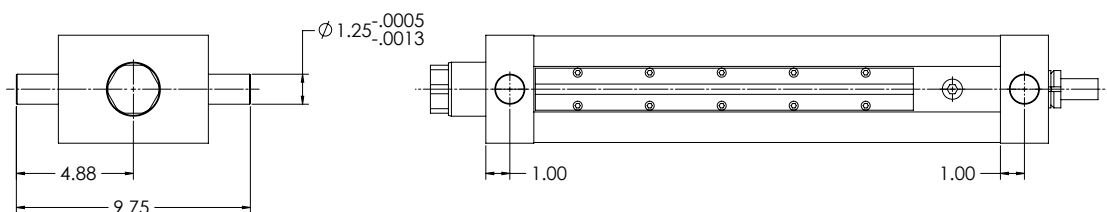

DIMENSIONED DRAWINGS FOR THE ELIMINATOR SS ACTUATOR

Dimensions in inches

Rod End Options

Self-Aligning Coupler

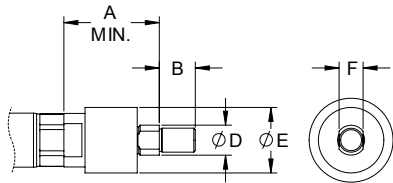

Male Thread

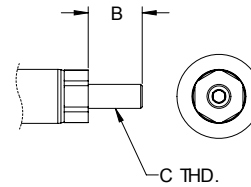

Spherical Rod Eye

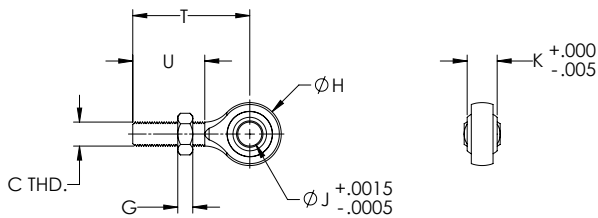

Female Eye

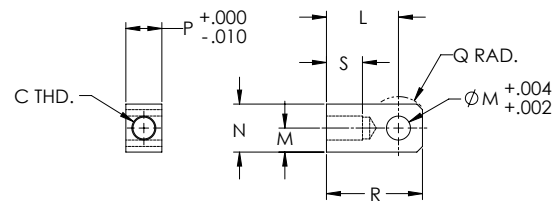

SS Rod End Dimensions

Model	A	B	C	D	E	F	G	H	J	K	L	M	N	P	Q	R	S	T	U
SS454	2.94	1.63	1 1/4-12	1.45	3.13	1.25	0.72	2.75	1.00	1.38	3.44	1.38	2.75	2.00	1.38	4.81	2.00	4.13	2.13